

INSTALLATION INSTRUCTIONS

Swiss Madison
well made forever

SKU	NAME
SM-AB546	Ivy® 60" x 30" Right-Drain Alcove Bathtub
SM-AB545	Ivy® 60" x 30" Left-Drain Alcove Bathtub
SM-AB540	Voltaire® 60" x 30" Right-Hand Drain Alcove Bathtub
SM-AB541	Voltaire® 60" x 30" Left-Hand Drain Alcove Bathtub
SM-AB542	Voltaire® 60" x 32" Right-Hand Drain Alcove Bathtub
SM-AB543	Voltaire® 60" x 32" Left-Hand Drain Alcove Bathtub
SM-AB550	Voltaire® 54" x 30" Right-Hand Drain Alcove Bathtub
SM-AB549	Voltaire® 54" x 30" Left-Hand Drain Alcove Bathtub



Share your pictures for a feature!
using **#SwissMadison** 

ALCOVE BATHTUB

INSTALLATION INSTRUCTIONS

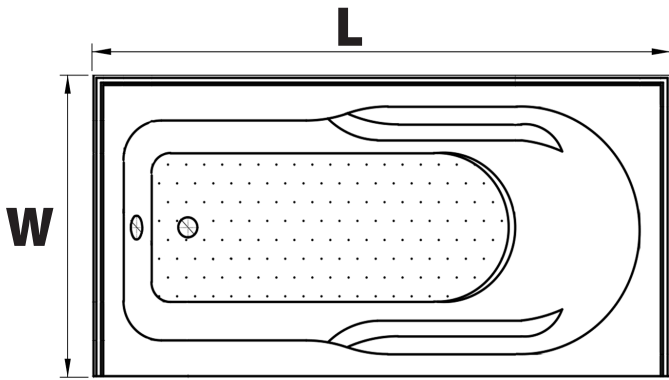

SKU	NAME	L x W x H	DRAIN
SM-AB546	Ivy®	60" x 30" x 20.5"	Right-Hand
SM-AB545	Ivy®	60" x 30" x 20.5"	Left-Hand
SM-AB540	Voltaire®	60" x 30" x 22"	Right-Hand
SM-AB541	Voltaire®	60" x 30" x 22"	Left-Hand
SM-AB542	Voltaire®	60" x 32" x 22"	Right-Hand
SM-AB543	Voltaire®	60" x 32" x 22"	Left-Hand
SM-AB550	Voltaire®	54" x 30" x 21.5"	Right-Hand
SM-AB549	Voltaire®	54" x 30" x 21.5"	Left-Hand

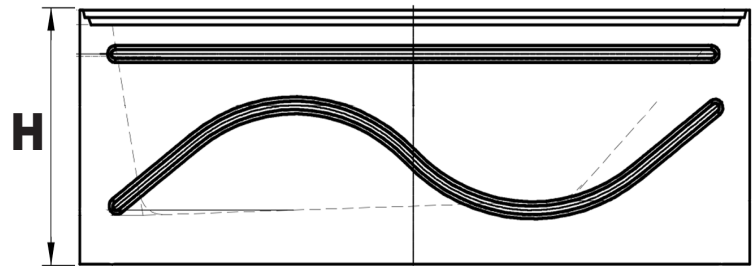

SUGGESTED TOOLS AND MATERIALS



Safety Glasses

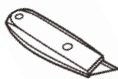

Utility Knife



Pencil

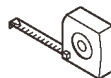

Tape Measure

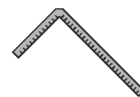

Square

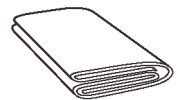

Drop Cloth

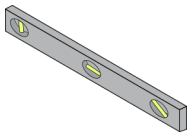

Level

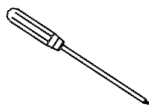

Screwdriver

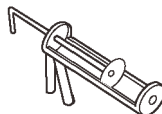

Caulk Gun

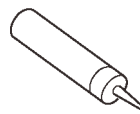

Adhesive
1 tube

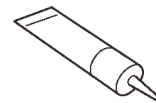

Sealant
1 tube

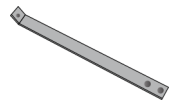

Cast Iron bar
3pcs.
(supplied)



Screw 6pcs.
(supplied)



WARNING: All plumbing installations must be done in accordance to legal regulations.



1. Read the complete instruction manual before beginning installation.
2. Confirm that your model will fit in intended location and plumbing fixtures are located where legally required before beginning installation.
3. Not all drawings on this manual are drawn to scale. Please refer to the model chart.
4. Walls and sub-floor must be solid, and square.
5. Always use drop cloth to protect bathtub from damage during installation.
6. **Two people must be used at all times to move and install bathtub.**



ATTENTION! Before installing the bathtub:

- Make sure all wood studs and supports are properly installed.
- Verify all the necessary plumbing is installed by a certified plumber.
- Floor drain and trap are not included. Make sure to install according to local and legal regulations.

Roughing-in

- Rough plumbing must be pre-installed by a certified plumber before Alcove Bathtub installation.
- If floor drain-hole installation is needed, contact a certified plumber.
- Place tub at final desired location and verify floor drain and bathtub drain align.

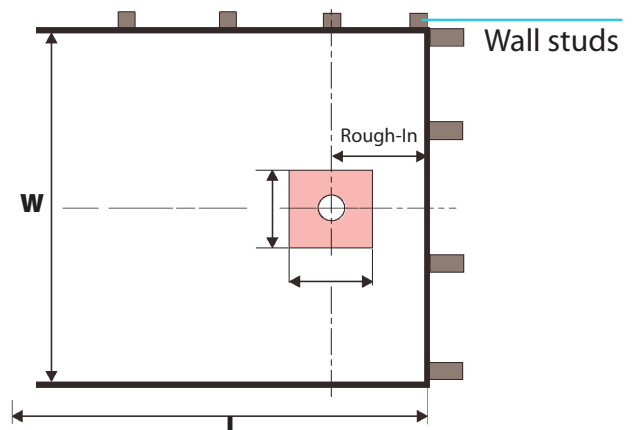
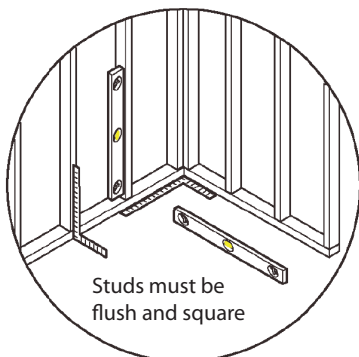
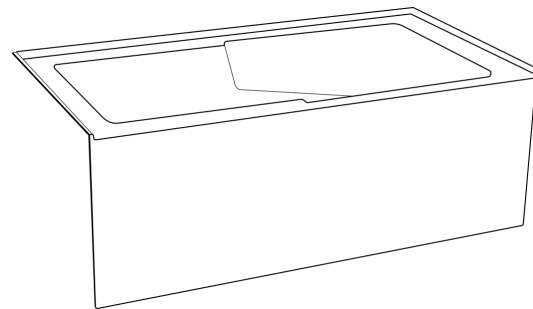
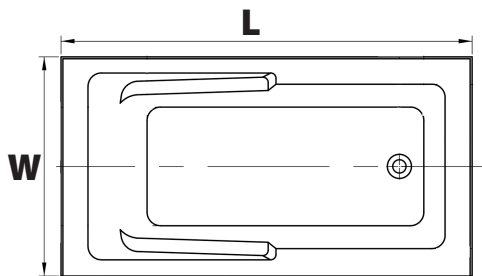

Attaching cast iron bars

ATTENTION! Assemble bathtub on drop cloth or rug to protect its surface.

1. Flip tub on upside-down using a drop cloth for protection.
2. Slide hook end of iron cast bar into position as seen in picture.
3. Use level tool to verify apron is vertical to the ground.
4. Screw cast iron bar (flat end) into raised wood platform on bottom of tub.
5. Repeat for all three supports.

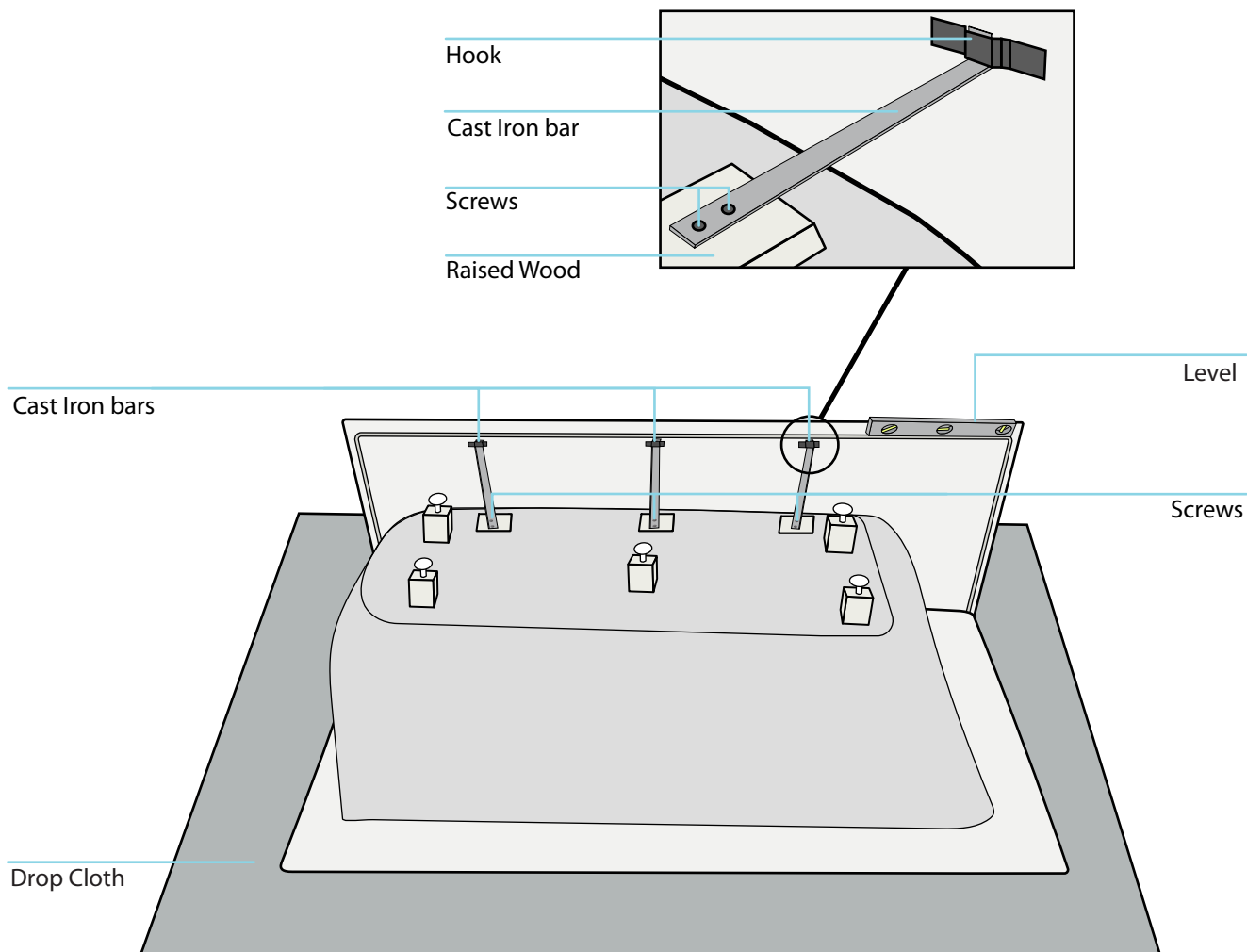

Leveling Bathtub

1. Flip tub back to standing position.
2. Adjust the leg height to ensure tub is level with floor and apron, verify tub is level using level tool.

Setting the Bathtub

1. Set down bathtub back in the predetermined location.
2. Use level tool to verify tub is flush with floor for maximum stability.
3. Apply bead of silicone sealant where the apron and floor meet to create a water tight seal.

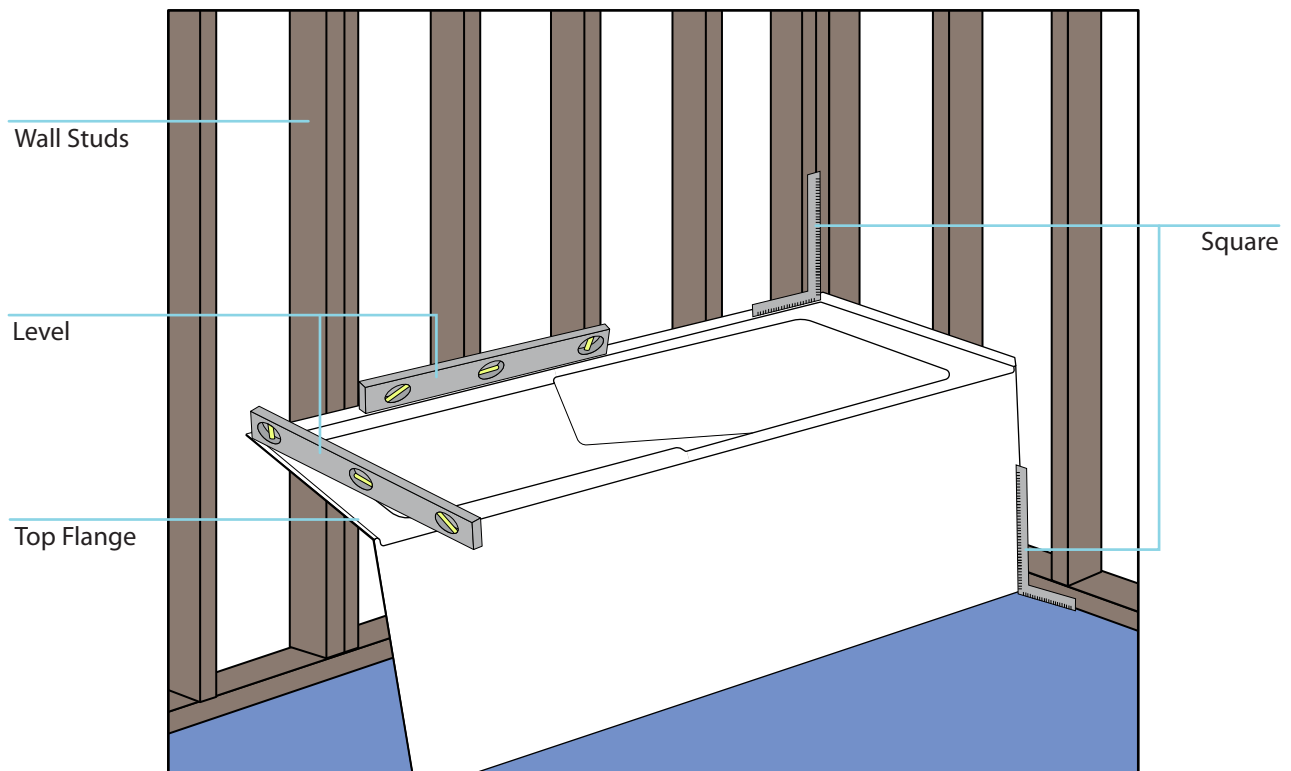



1-434-MADISON

(623-4766)

19 Stulds Rd., Dayton, NJ 08810

www.swissmadison.com

ONE YEAR LIMITED WARRANTY

Swiss Madison® products are made with quality materials and excellent craftsmanship to provide the customers a long lasting product. In the case of any defects in materials or craftsmanship under regular use were inspected in the first year of purchase, Swiss Madison® will provide replacement parts at no charge, or at its option, replace any product or part of the product that is deemed defective, under normal installation, use, service and maintenance. This warranty applies only to the original purchaser. Proof of purchase will be required in the case of a claim.

Swiss Madison® recommends the installations to be made by a licensed, professional plumber. Swiss Madison® will not be held responsible for any damage or product failure due to improper installation, misuse, or failure to use a licensed professional. Swiss Madison® is not responsible for any removal or installation cost.

This One Year Limited Warranty will be voided if:

- The installation recommendations were not followed.
- The product has been moved from it's initial place of installation.
- The product has been modified.
- The product has been subjected to improper maintenance, abuse, misuse, excessive use of chemicals, accident or other damages.

Swiss Madison® makes no implication that products comply with any or all local building or plumbing codes. It is the consumer's responsibility to determine local code compliance. This warranty extends to the original purchaser and first consumer.

Swiss Madison® is not liable for any incidental, consequential or special damages associated with the return, replacement, installation or use of your product. This includes freight costs, labor, travel time, lost profit, home damages and other contingent liabilities and costs (including, without limitation, costs associated with experts, investigations, analyses, attorneys and other professionals and services).

The Swiss Madison® warranty is a comprehensive and explicit limit of liability, and all items outside of it are not addressable by or the responsibility of Swiss Madison®. Certain states have variances regarding implied warranties and in those situations we remain fully compliant.

In the case of any questions or a claim contact us directly at 1-434-MADISON (623-4766).

WARNING: Content may contain sharp and other possibly harmful pieces and may cause hazard to children and adults, Swiss Madison® is not responsible in any way for personal damage.